

nordlux®

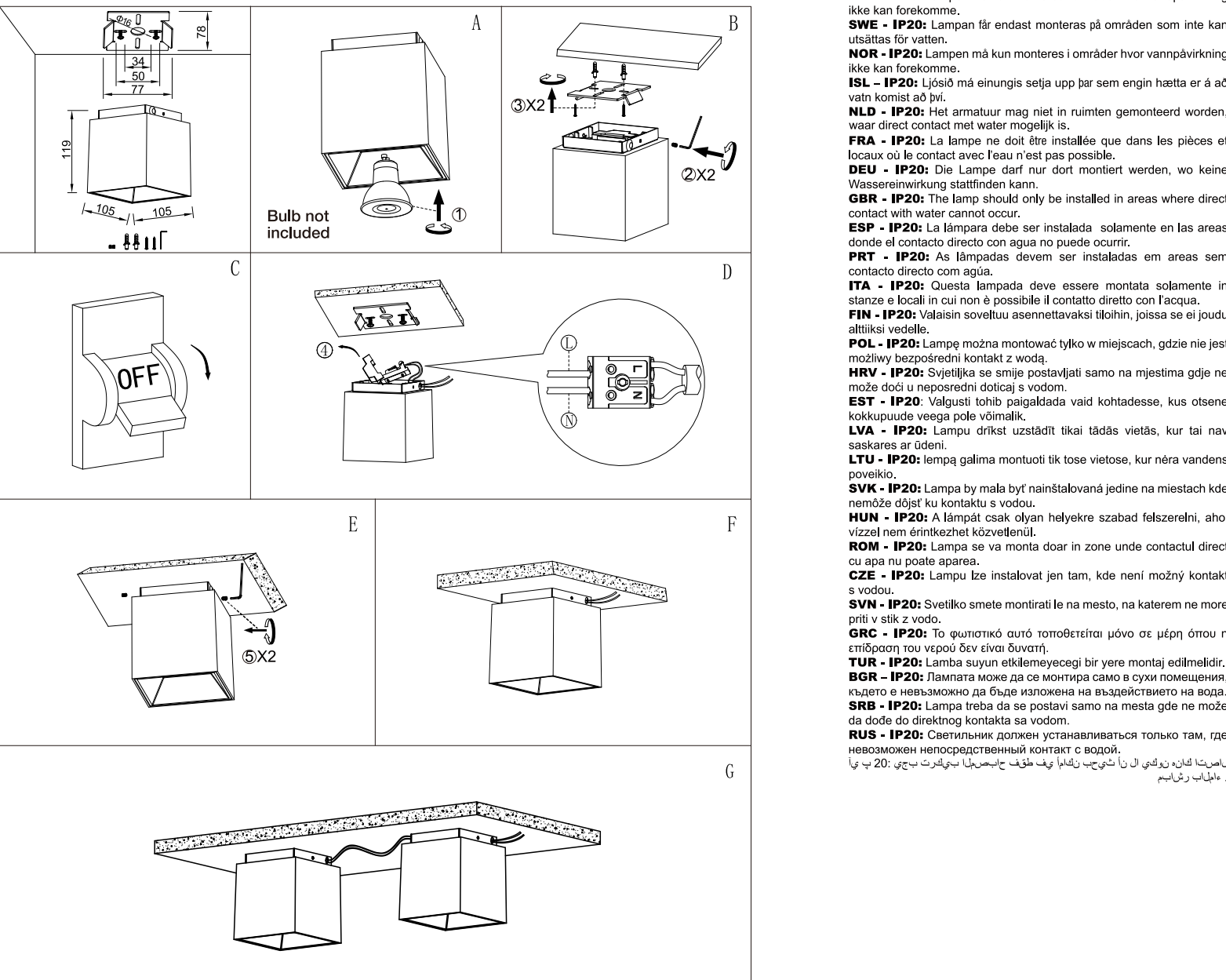

ETHAN

Monteringsanvisning | Montageanleitung | Mounting instruction | Installationsanvisning | Instructions de montage | Montage-instructies | Item №: 211040

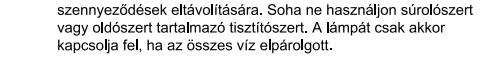
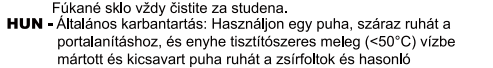
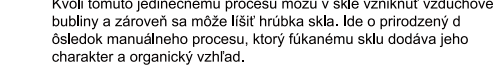
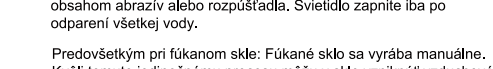
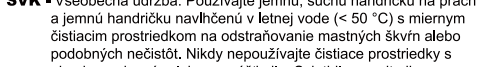
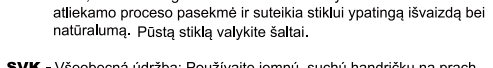
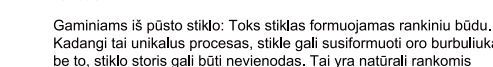
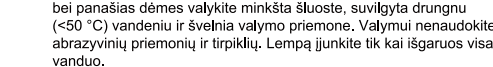
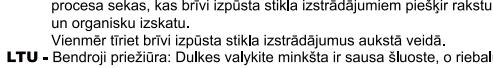
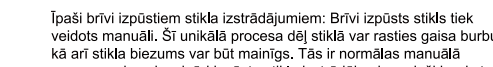
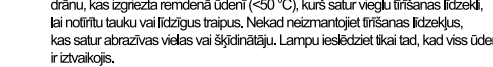
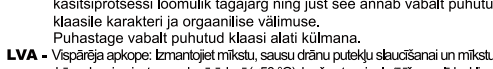
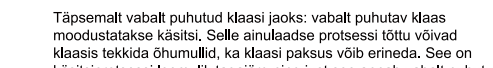
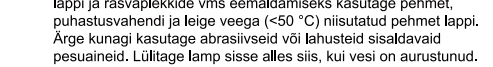
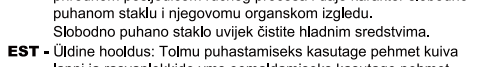
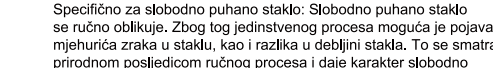
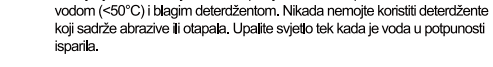
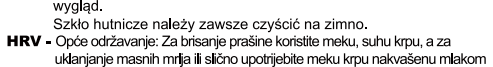
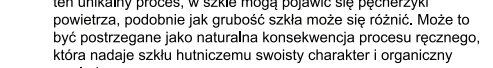
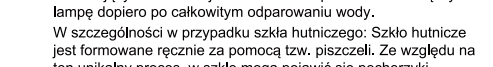
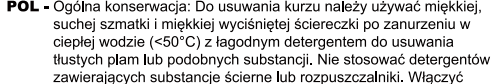
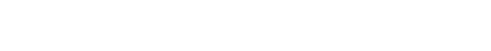
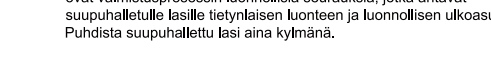
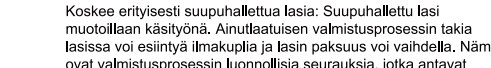
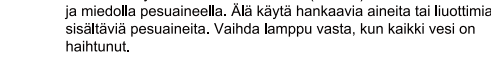
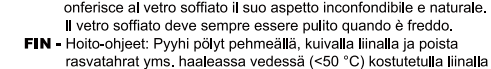
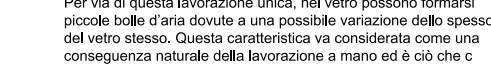
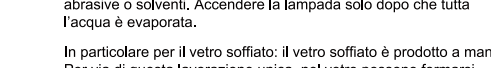
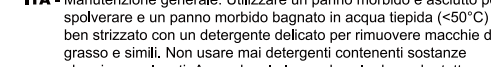
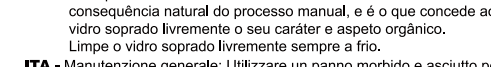
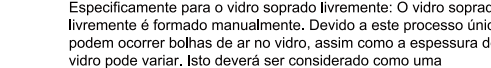
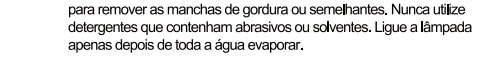
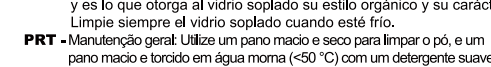
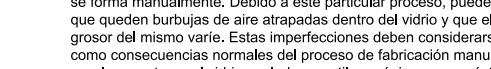
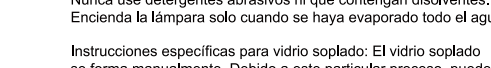
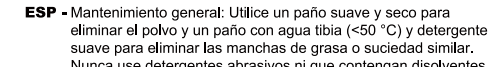
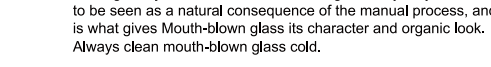
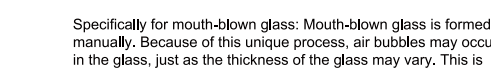
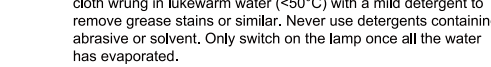
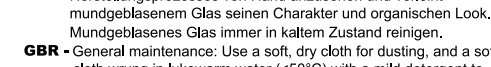
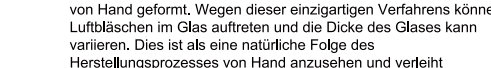
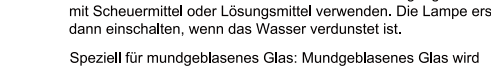
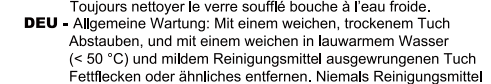
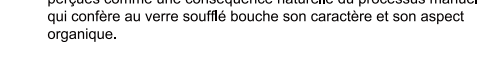
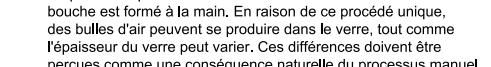
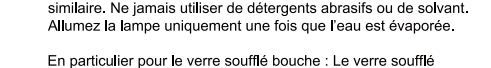
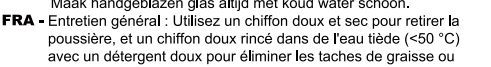
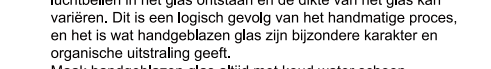
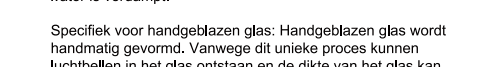
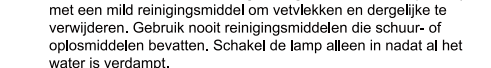
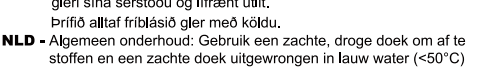
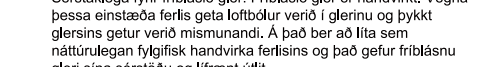
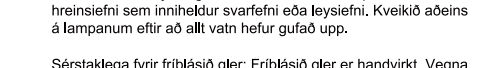
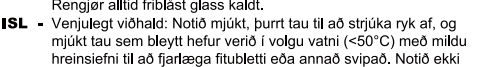
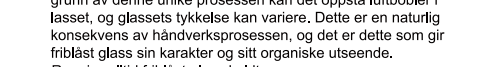
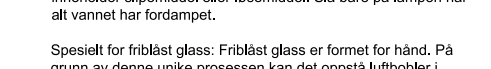
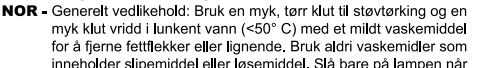
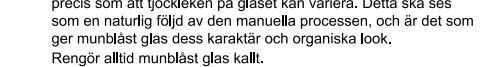
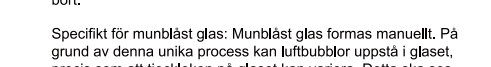
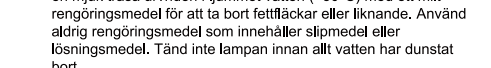
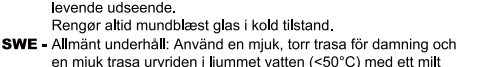
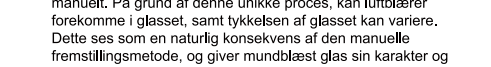
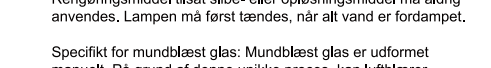
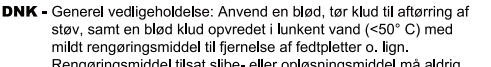
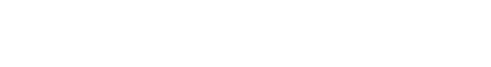
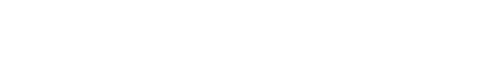
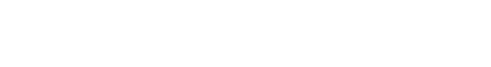
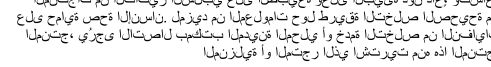
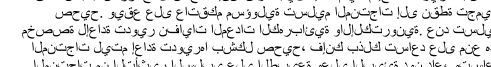
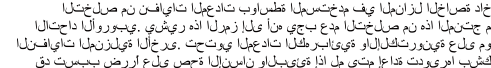
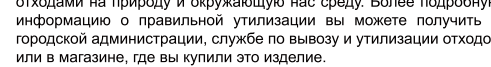
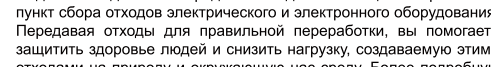
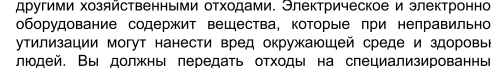
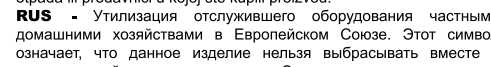
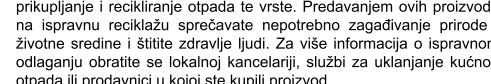
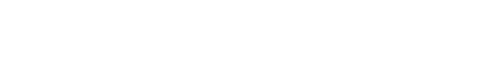
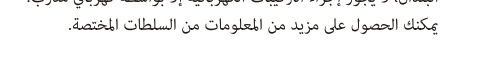
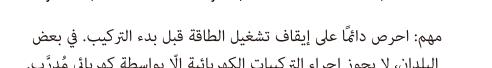
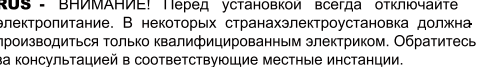
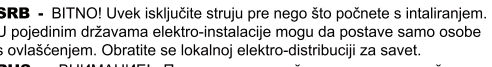
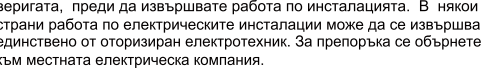
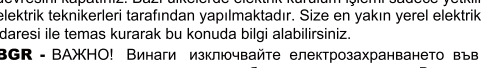
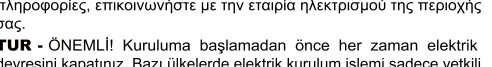
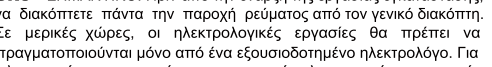
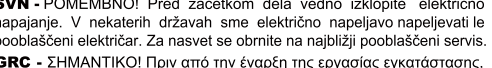
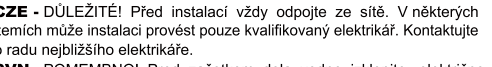
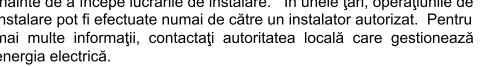
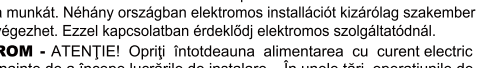
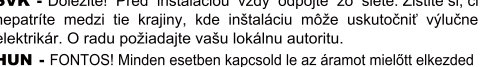
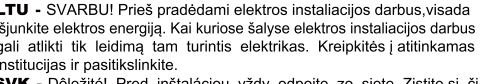
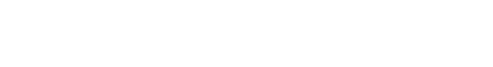
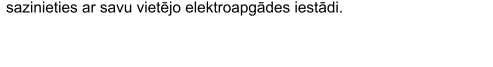
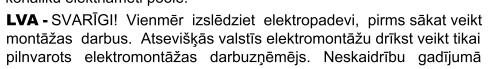
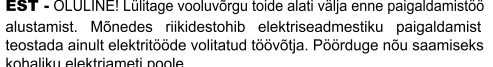
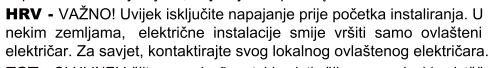
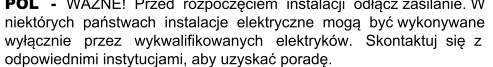
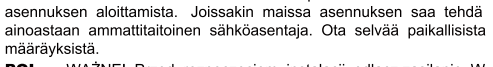
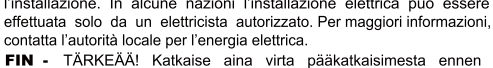
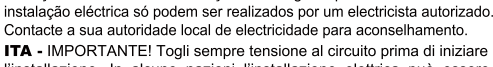
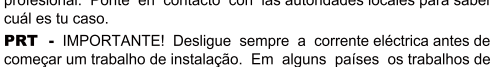
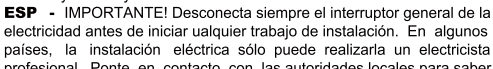
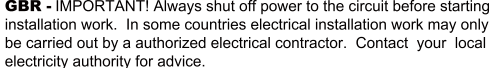
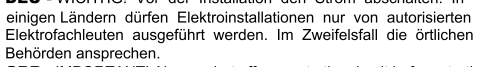
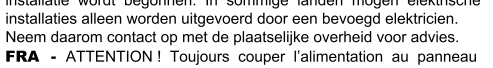
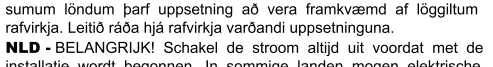
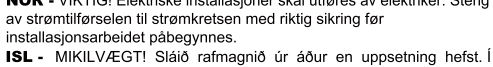
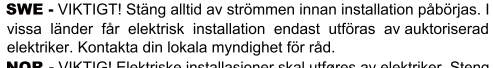
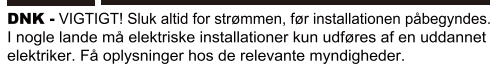
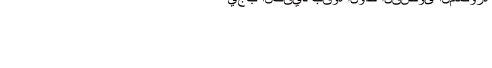
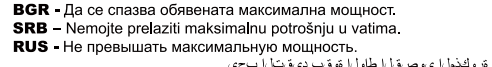
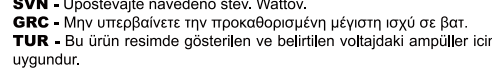
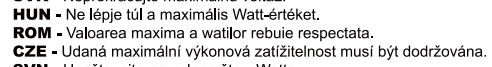
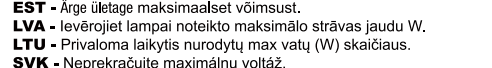
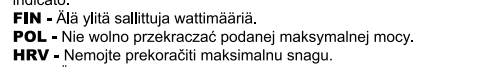
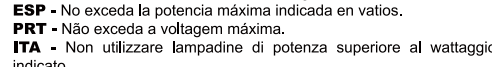
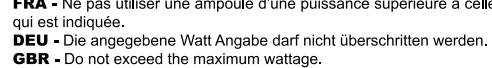
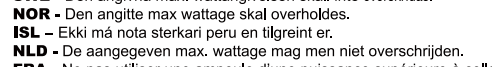
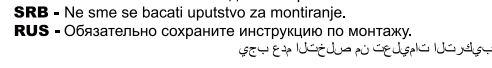
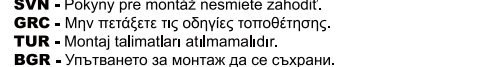
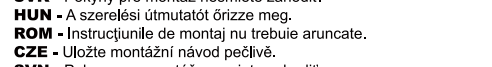
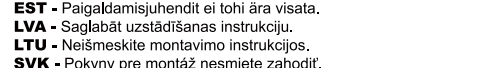
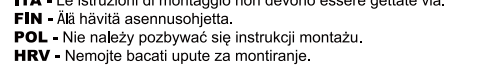
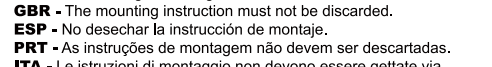
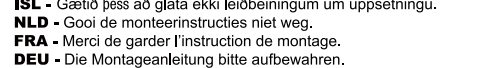
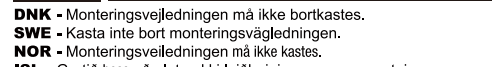
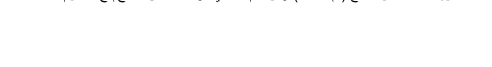
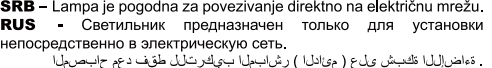
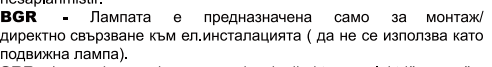
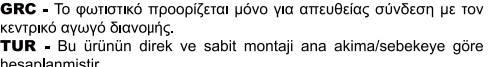
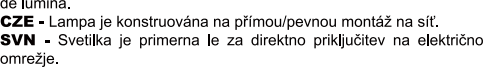
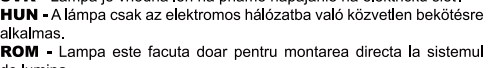
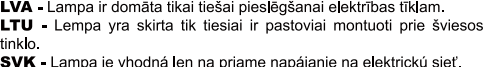
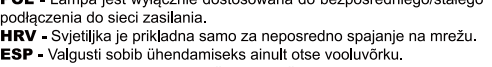
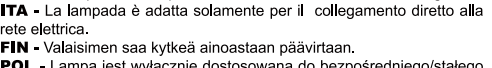
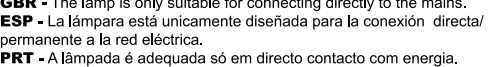
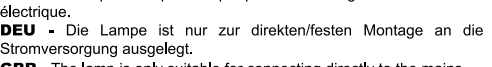
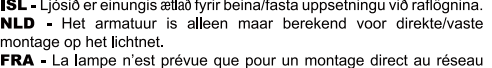
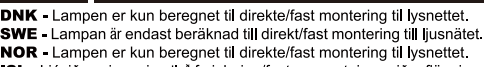

Kifejezette a fővett üvegre vonatkozóan: A fővett üveget kézzel formázzák. Az egyedi megmunkálásból adódóan legbuborékok lehetnek az üvegekben, és az üveg vastagsága is változó lehet. Ez a közeli megmunkálás természetes velejárója, ami a fővett üvegek egyedi jellegét és természetét megjeleníti ad. A fővett üveget mindig hidegen kell tisztítani.

ROM - Instruire generală: Utilizați o cârpă moale, uscată pentru ștergere și o cârpă moale, stoarsă, înmuiată în apă caldă (<50 °C) cu detergent blând, pentru îndepărtarea petelor de grăsime sau a altor astfel de impurități. Nu utilizați niciodată detergenți care conțin substanțe abrazive sau solventi. Aprindeți lampa doar după ce toată apa s-a evaporat.

Special pentru sticlă sulfată liber: Sticlă sulfată liber este realizată manual. Din cauza acestui proces unic, se pot forma bule de aer în sticlă, iar grosimea acesteia poate varia. Este o consecință naturală a procesului manual și totodată este ceea ce conferă sticlei sulfată liber caracterul specific și aspectul organic. Sticlă sulfată liber se curăță întotdeauna rece.

CZE - Běžná údržba: K odstranění mastných skvrn nebo podobných znečištění používejte suchý měkký hadřík na stírání prachu a měkký hadřík namočený ve vlhké vodě (< 50 °C) s jemným čisticím prostředkem. Nikdy nepoužívejte čisticí prostředky obsahující abrazivní látky či rozpouštědla. Lampu rozsviňte až poté, co se všechna voda vypaří.

Speciálně pro ručně foukané sklo: Foukané sklo se tvoří ručně. Vlivem tohoto jedinečného procesu se mohou ve skle objevit vzduchové bubliny a může se také lišit tloušťka skla. To je přirozený důsledek ruční výroby a právě tyto vlastnosti dávají foukanému sklu jeho charakter a přirozený vzhled.

Foukané sklo vždy čistěte za studena.
SVN - Splošno vzdrževanje: Uporabite mehko suho krpo za brisanje prahu, za odstranjevanje mastnih madežev pa ožeto mehko krpo, ki je pred tem namočena v mlačno vodo (<50 °C) z blagim čistilnim sredstvom. Nikoli ne uporabljajte čistilnih sredstev, ki vsebujejo abrazivne ali topila. Svetilko vklopite le nato, ko vsa voda izhlapi.

Večja posebej za prsto pihano steklo: Prosto pihano steklo se oblikuje ročno. Zaradi tega edinstvenega procesa lahko v steklu nastanejo mehurčki zraka, prav tako pa je debelina stekla lahko različna. To se upošteva kot naravna posledica ročne obdelave, zaradi česar prsto pihano steklo dobi svoj poseben značaj in organski videz.

Prosto pihano steklo vedno čistite hladno.

GRG - Γενική συντήρηση: Χρησιμοποιήστε ένα μαλακό, στεγνό πανί για το ξύσκονημα και ένα μαλακό πανί που μουλιάσε σε υδαρό νερό (<50 °C) με ένα ήπιο απορρυπαντικό για να αφαιρέσετε λεκέδες από λάδι ή από ποτό. Ποτέ μην χρησιμοποιείτε απορρυπαντικά που περιέχουν λαβηρό ή βελόνες. Ενεργοποιήστε τη λάμπα μόνο αφού εξημεστεί όλο το νερό.

Συγκεκριμένα για φυσικό γυαλί: Το φυσικό γυαλί μορφοποιείται με το χέρι. Λόγω αυτής της μοναδικής διαδικασίας, μπορεί να εμφανιστούν φυσαλίδες αέρα στο γυαλί, όπως και το πάχος του γυαλιού μπορεί να ποικίλει. Αυτό πρέπει να θεωρηθεί ως μια φυσική συνέπεια της χειροκίνητης διαδικασίας, και είναι αυτό που δίνει το φυσικό γυαλί τον χαρακτήρα και την οργανική εμφάνιση του.

Οι τρέμπι πάντα να καθαρίζετε το φυσικό γυαλί όταν είναι κρύο.

TUR - Genel bakım: Tozunu almak için yumuşak, kuru bir bez, yağ lekelerini ve benzer lekeleri çıkarmak için ise hafif deterjanlı ılık suya (<50°C) batılmış yumuşak bir bez kullanın. Ağır deterjanlı veya etkil madde içeren deterjanları hiçbir zaman kullanmayın. Lambayı ancak tüm su buharlaşmadan sonra yakın.

Özellikle serbest üfleme cam için: Serbest üfleme cam elle yapılır. Bu özel işlemin sonucunda camda hava kabarcıkları oluşabilir ve camın kalınlığı da değişiklik gösterebilir. Bu da serbest üfleme camın karakterini ve organik görünümünü verir ve elle yapmanın doğal bir sonucu olarak görülmelidir.

Serbest üfleme camı daima soğukken temizleyin.
BGR - Обща поддръжка: Използвайте мека, суха кърпа за прах и мека кърпа, напоена с хладка вода (<50 °C) с мек почистващ препарат, за да премахнете мазни петна или други подобни. Никога не използвайте почистващи препарати, съдържащи абразивно средство или разтворители. Включете лампата само след като цялата вода се е изпарила.

Специално за ръчно духано стъкло: Ръчно духаното стъкло се оформя ръчно. Поради този уникален процес, в стъклото може да има мехурчета и дебелината на стъклото може да варира. Това трябва да се разглежда като естествена последица от ръчния процес и е това, което придава на ръчно духаното стъкло неговия характер и органичен вид.

Винаги почиствайте ръчно духаното стъкло студено.

SRB - Opšte održavanje: Za brisanje prašine koristite meku, suhu krpu, a za uklanjanje masnih mrlja ili slično upotrebite meku krpu potopljenu mlakom vodom (<50 °C) i blagim deteržentom. Nikada nemojte koristiti deteržente koji sadrže abrazive ili rastvarače. Upalite svetlo tek kada je voda u potpunosti isparila.

Specifično za slobodno duvano staklo: Slobodno duvano staklo se oblikuje ručno. Zbog tog jedinstvenog procesa moguća je p ojava mehurića vazduha u staklu, kao i odstupanje debljine stakla. To se smatra prirodnim posledicom ručnog procesa i odlika je karaktera slobodno duvanog stakla i njegovog organskog izgleda. Slobodno duvano staklo uvek čistite hladnim sredstvom.

RUS - Общие указания по уходу: Протрите мягкой сухой тканью для удаления пыли. Для удаления жирных пятен и т. п. используйте хорошо выжатую тряпку, смоченную в теплом мыльном растворе (<50 °C) из воды с мягким моющим средством. Ни в коем случае не используйте моющие средства, содержащие абразив или растворитель. Включайте лампу только после полного испарения воды.

Особо для стеклоделания свободного выдувания: Стеклоделание свободного выдувания (так называемое гутное стекло) изготавливается без формы, вручную. Вследствие этого уникального процесса в стекле могут образовываться пузырьки воздуха, толщина стекла также может варьироваться. Это следует рассматривать как естественное следствие ручного процесса, придающее гутному стеклу его характерный, уникальный вид.

Мойте стеклоделания свободного выдувания только холодной водой.

دعمت عام عربیًا جميل علم عام قومان شرايق دعتی دعتی. انجانا قارونیا. انروسینج (قوری وید 50 نه لقا) رتاف نام وید قاروسو انرجان شرايق دعتی انیا دچسترت ان. صلی او او موچینا عیب داران طنتیم عظیم نام عم جاصینا دتوت ان. دتیم نام وید ویدت ویدتا دتصفتینا انیا انیا عیب رخصت دعب انرا

عینلاب لکشلی انجانا لکشلی. رچلا عینلاب لکشلی انجانلاب صراع وید اوولنا شاعرف دچرتت بق. دتورفنا اولمچیا داد بوسوسو. انودی رچلا اولمچلی انیا عیب طنتیم انلا دچوو. انجانا انیس فیلتیج بق. انه. وچ انجانا دتورفنا صراعصراع رچلا عینلاب لکشلی انجانا. چدی او وود. دتورفنا بوسوسول مطبو

انرا. وود رچلا عینلاب لکشلی انجانا فیلتیج وید انیا صراجا

nordlux®
www.nordlux.com

Nordlux AS | Bølle Hemmings 34 | DK-9000 Aalborg | Monteringsanvisning | Montageanleitung | Mounting instruction | Installationsanvisningar | Instructions de montage | Montage-instructies