

**COMMODE MATCHA/ CHEST OF DRAWERS MATCHA/
KOMMODE MATCHA/ CÓMODA MATCHA/ CASSETTIERA MATCHA**

REF : 56474

Notice de montage / Assembling Instruction / Instrucciones de montaje /
Istruzioni di montaggio

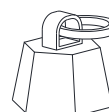
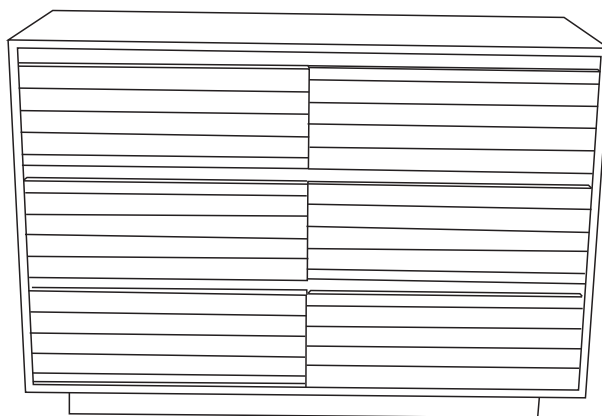

< 60 kg

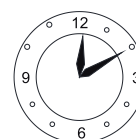

10'



FRANÇAIS	ENGLISH
<ul style="list-style-type: none"> > Consacrez quelques minutes à la lecture de cette notice de montage avant de suivre pas-à-pas les différentes étapes d'assemblage > Vérifiez que vous disposez de toutes les pièces et accessoires nécessaires au montage de votre meuble avant de jeter tout emballage > Effectuez votre montage sur une surface plane > Ne serrez pas les vis au maximum avant la fin du montage > Jetez les pièces supplémentaires et gardez les hors de portée des enfants 	<ul style="list-style-type: none"> > We suggest you spend a short time reading through this leaflet and follow the simple step-by-step assembly instructions. > Do not discard any of the packaging until you have checked that you have all the parts and the pack of fittings. > Assemble this product on a flat surface. > Assemble all parts loosely before tightening any bolts. > Discard all extra fittings and keep fittings out of reach of children.
ESPAÑOL	ITALIANO
<ul style="list-style-type: none"> > Dedique unos minutos a la lectura de estas instrucciones para seguir paso a paso las etapas de montaje. > Compruebe que dispone de todas las piezas y accesorios necesarios al montaje antes de tirar los embalajes > Efectúe el montaje sobre una superficie plana > No apriete los tornillos al máximo hasta el final del montaje > Lanzar piezas adicionales y mantenerlos fuera del alcance de los niños 	<ul style="list-style-type: none"> > Leggere attentamente le istruzioni di montaggio prima di cominciare > Prima di buttare il cartone d'imballo verificare scrupolosamente che nessun elemento nè accessorio sia mancante > Effettuare il montaggio su una superficie piana > Non serrare le viti al massimo prima della fine del montaggio > Buttare i pezzi supplementari e tenerli fuori portata dei bambini

Retrouver l'intégralité de nos collections sur www.miliboo.com. Pour plus d'information veuillez nous contacter au 08 05 14 44 44 (numéro vert) ou par email info@miliboo.com

Find all our collections on www.miliboo.co.uk. For more information please contact us at 0203 355 98 09 (toll free) or by email at info@miliboo.com

Vea toda nuestra colección en www.miliboo.es. Para más detalle, nos puede llamar al 933 96 87 86 o mandar un correo electrónico a miliboo@miliboo.es

Ritrovi la totalità della nostra collezione su www.miliboo.it. Per ulteriori informazioni contatti lo 06 99 26 81 42 o invii una mail a info@miliboo.it





Brackets x
2 pieces

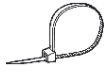

Strap x
2 pieces

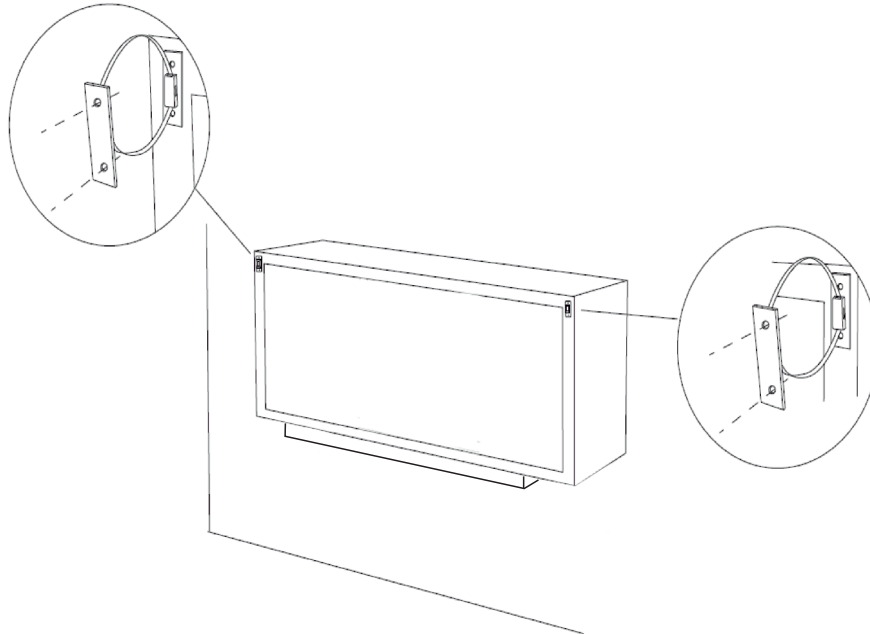

Fixation du Meuble



Il existe une grande diversité de types de murs ou cloisons, c'est la raison pour laquelle le type exact de fixation ne peut être fourni. Il est nécessaire d'identifier le type de paroi à laquelle vous allez fixer ce produit afin de vous procurer les fixations appropriées. Voici quelques exemples de fixations conseillées pour:

LES MURS PLEINS

CHEVILLE NYLON

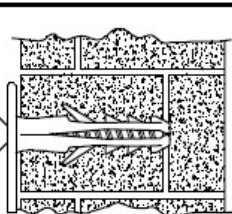
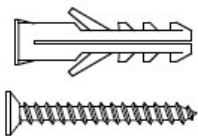

CHEVILLE D'ANCRAGE MÉTAL

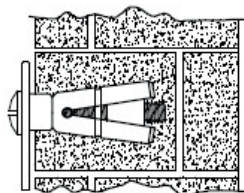
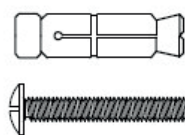

CHEVILLE D'ANCRAGE MÉTAL
A AILETTES EN NYLON

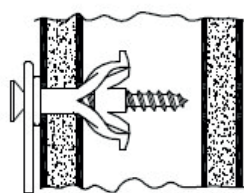
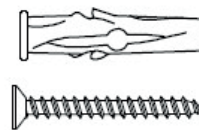

LES CLOISONS CREUSES

CHEVILLE MÉTALLIQUE A EXPENSION

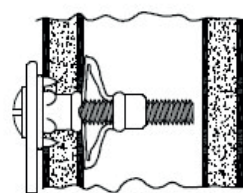
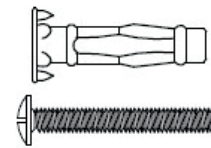

CHEVILLE "MOLLY"

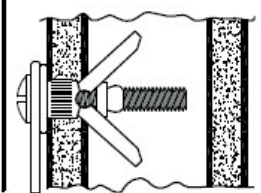
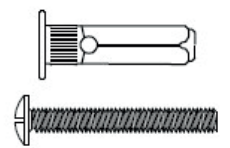

Utiliser un diamètre de forêt adapté à la cheville utilisée

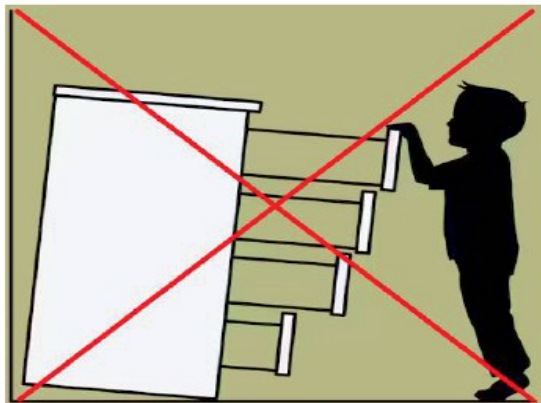

FR :

Pour des raisons de sécurité, veuillez suivre les instructions de montage et sécuriser vos meubles avec la fixation murale fournie. N'ouvrez pas plus d'UN tiroir à la fois.

EN :

For security concerns, please follow the assembly instructions and secure your furniture with the accompanying attachment devices. Do not open more than ONE drawer at a time.