

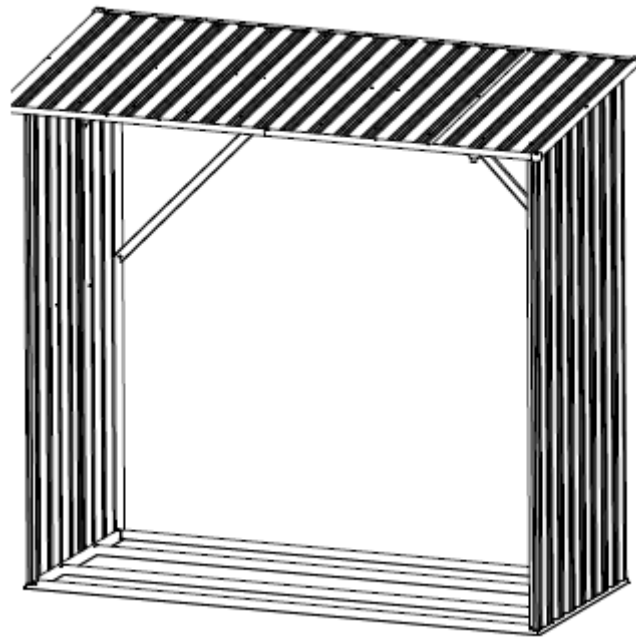























Abri bûche Vienne





IMPORTANT :

- 1.choisissez un endroit propre et sobre pour l'assemblage. Évitez les surfaces des mains qui pourraient endommager le produit.
2. Faites attention, lorsque vous soulevez le produit, veillez à ce qu'il soit assemblé aussi près que possible du point d'utilisation.
3. Assurez-vous de disposer de tout le contenu requis (pièces et objets) pour un assemblage complet.
4. Lisez toujours attentivement les instructions de montage avant de commencer le montage.
6. Gardez toutes les pièces de la quincaillerie et l'emballage hors de la portée des jeunes enfants
7. Ne serrez pas trop les vis et les boulons car cela pourrait endommager le filetage

Éléments

PIECE	NUM	QTITE	PIECE	NUM	QTITE
	1	2		P1	1
	2	4		P2	1
	3	2		P3	1
	4	2		P4L	1
	5	2		P4R	1
	6L	1		P5	1
	6R	1		P6	1
	7	2		P7	1
	8	2		P8	1
	9L	1		GC	4
	9R	1		GS	2
	10	2			
	11	2			

Visseries

PIECE	NUM	QTITE
	W1	4
	F1	105
	F2	10

WS-B1

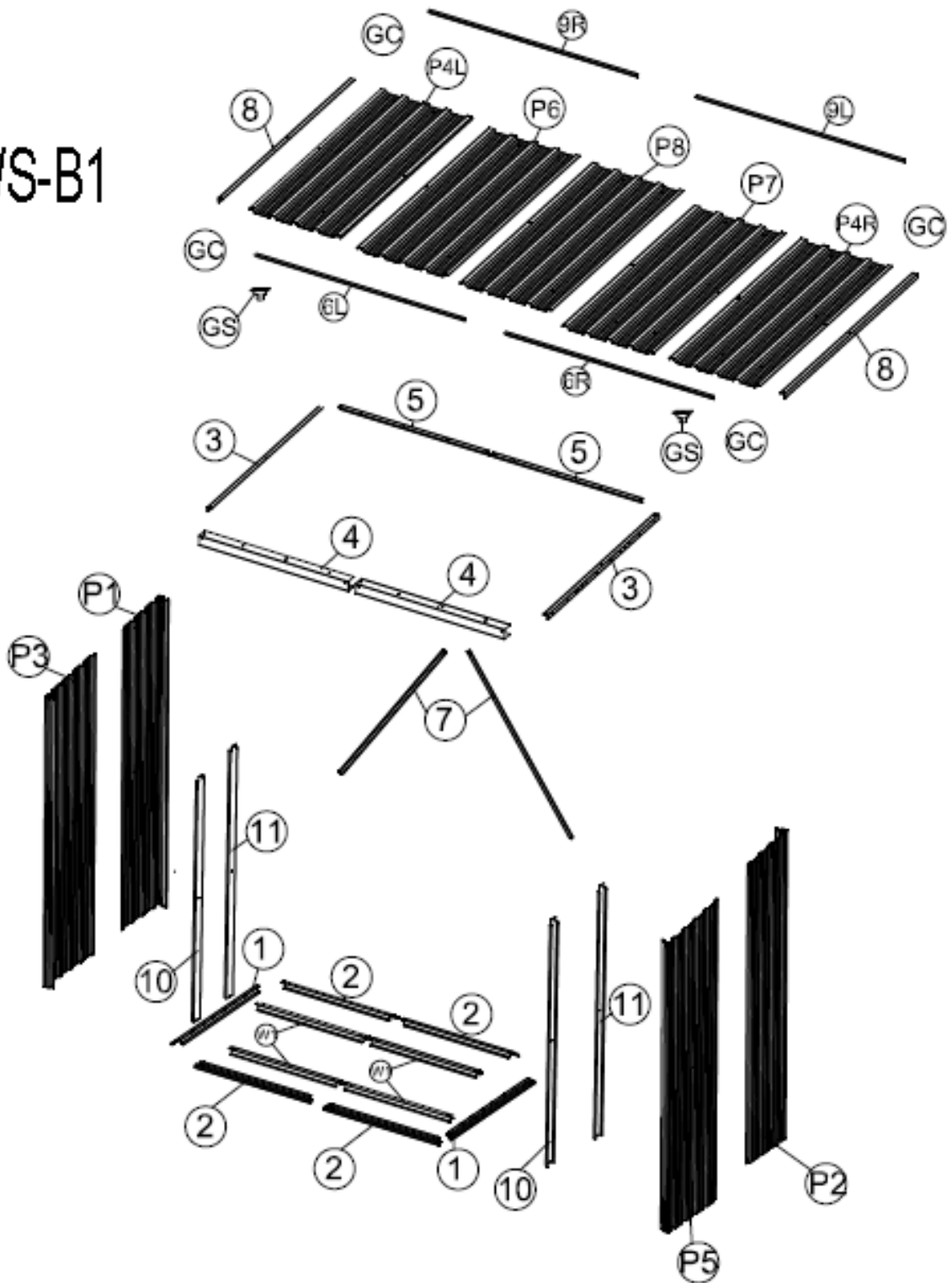

Etape 1 :

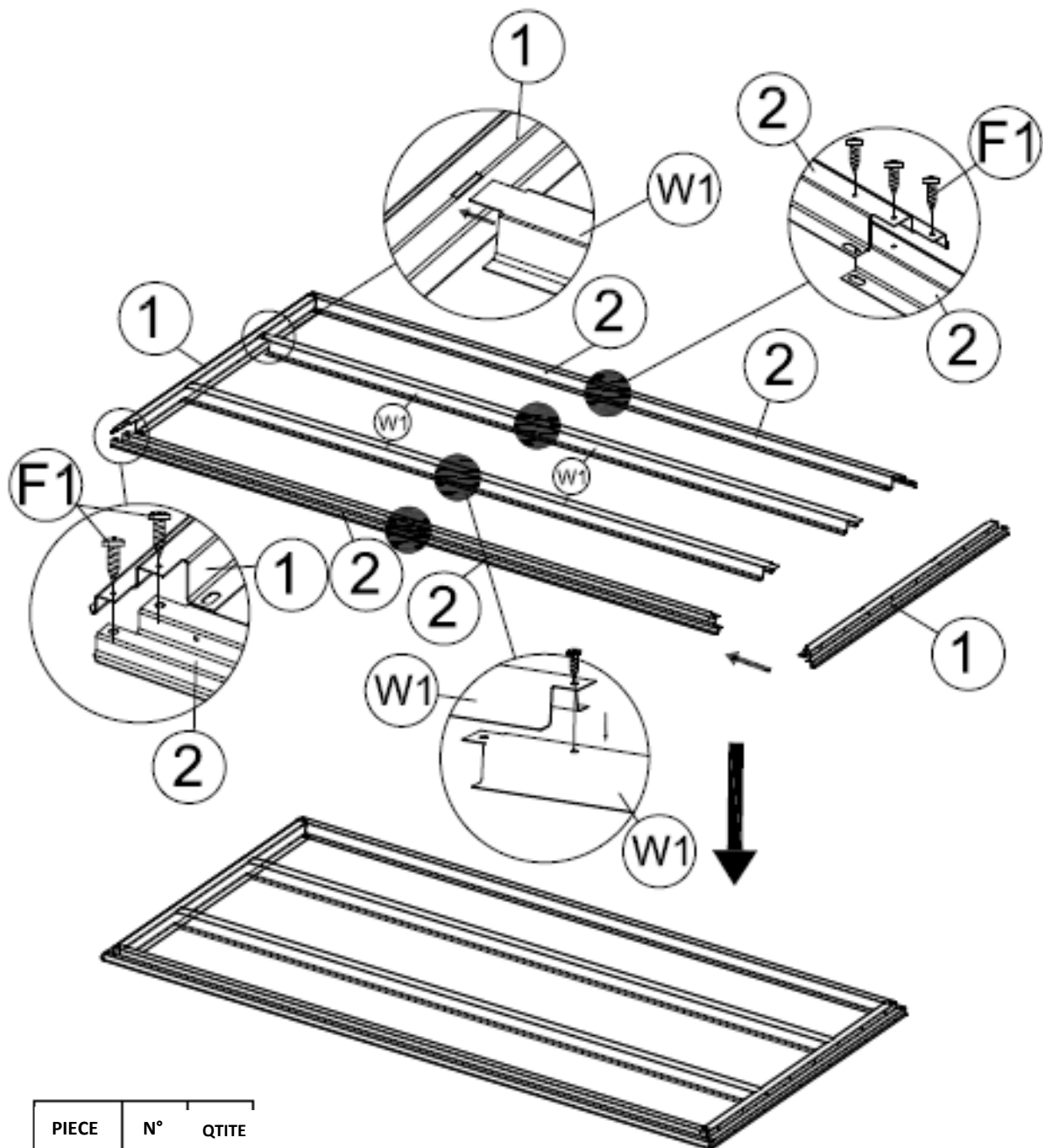

PIECE	N°	QTITE
	1	2
	2	4
	W1	4
	F1	18

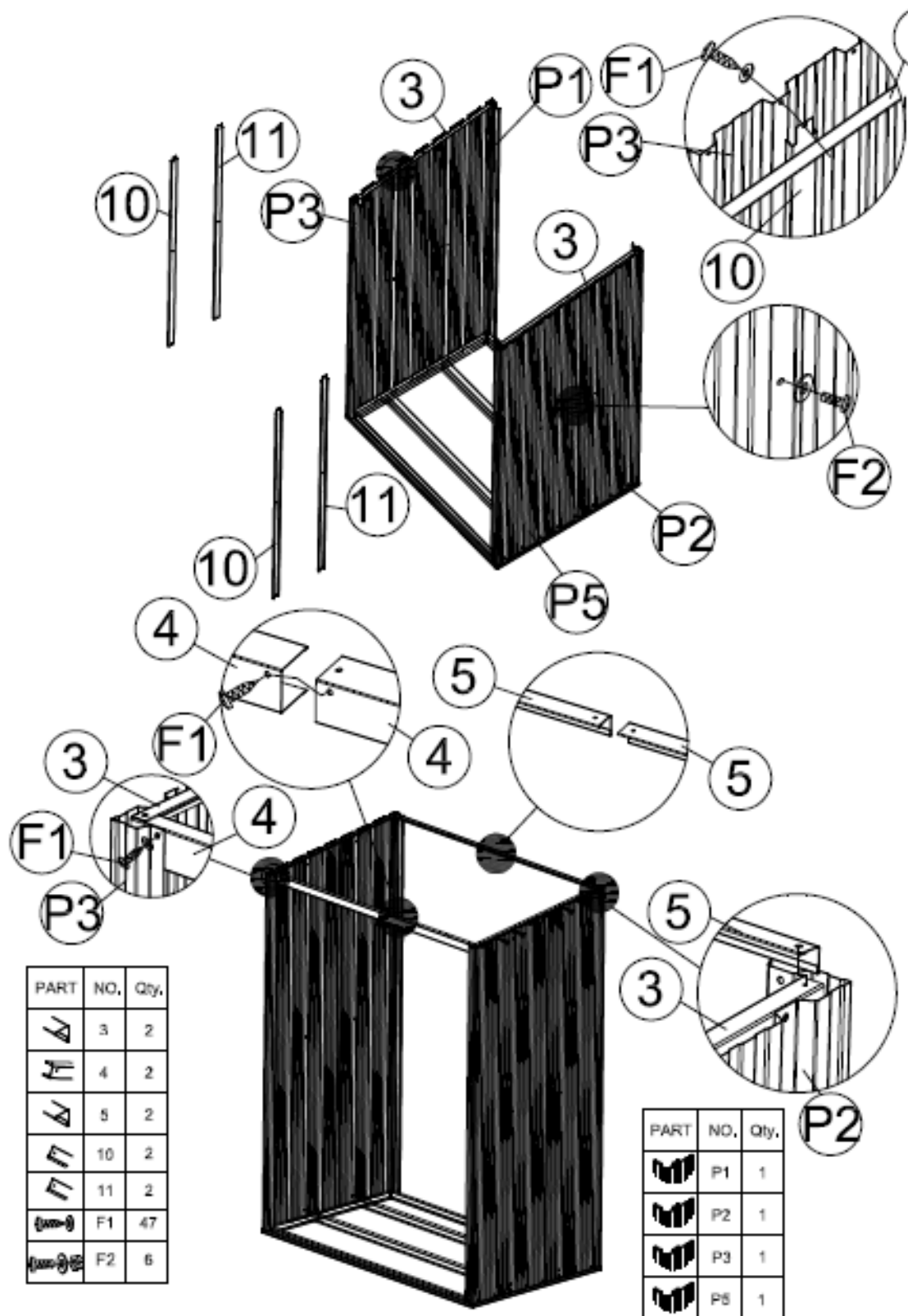

Etape 2 :

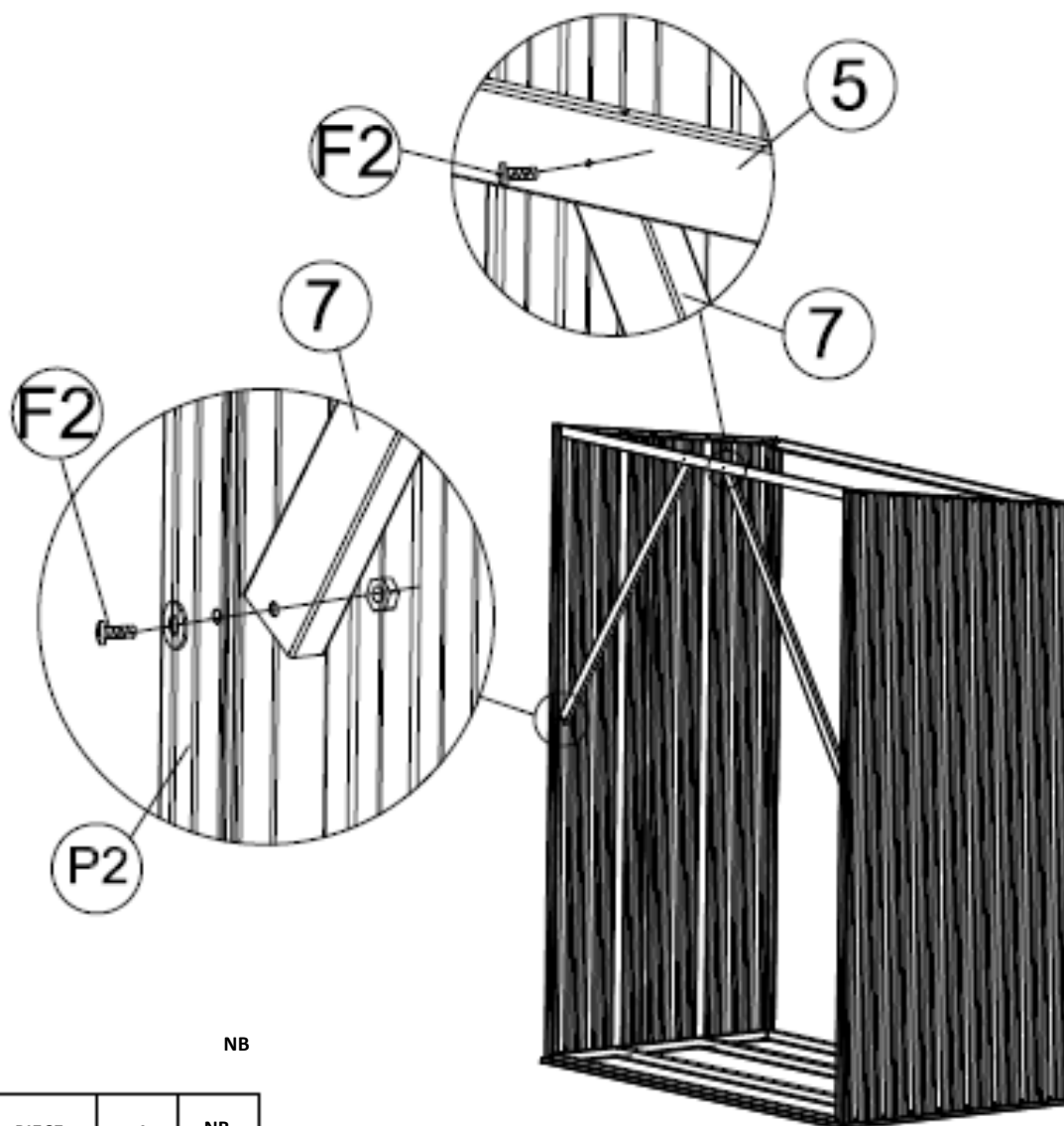

Etape 3 :







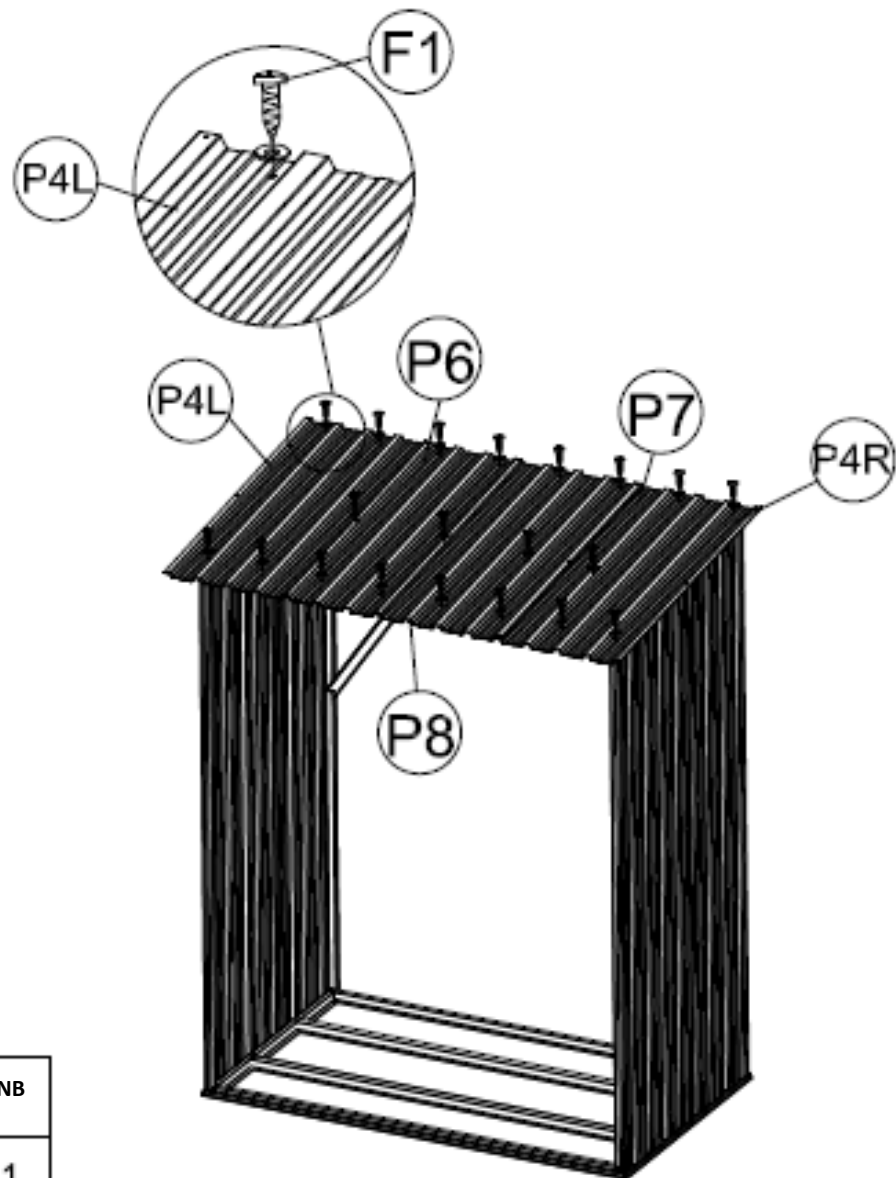

NB

PIECE	N°	NB
	7	2
	F2	4

Etape 4 :



PCE	N°	NB
	P4L	1
	P4R	1
	P6	1
	P7	1
	P8	1
	F1	24

Etape 5 :

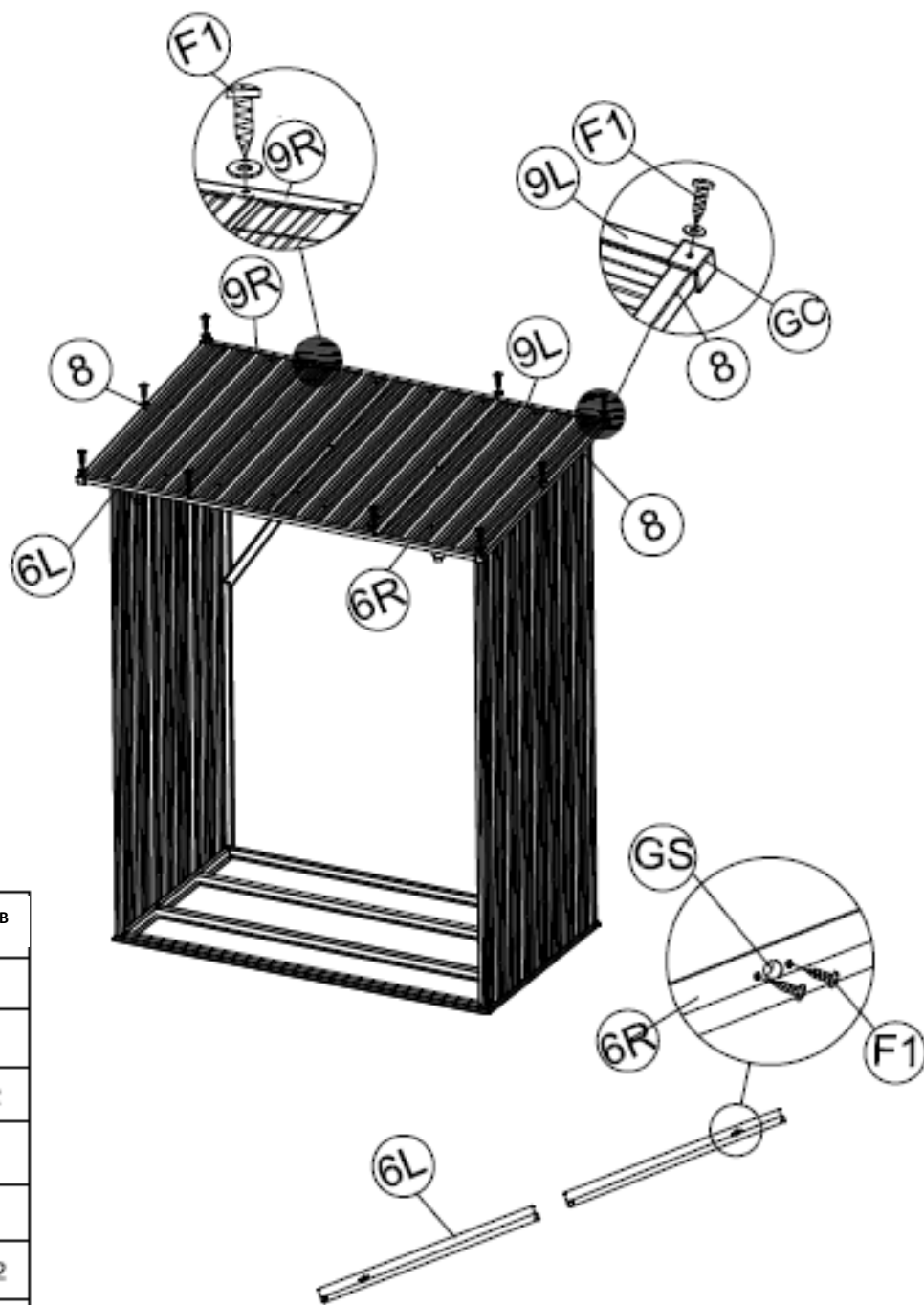

PCE	N	NB
	6L	1
	6R	1
	8	2
	9L	1
	9R	1
	GS	2
	GC	4
	F1	16